

Type: Coaxial Isolator series
Model no.: YXC1801F8
Features

1. Frequency range is from 8GHz to 12GHz
2. Reliable performance and competitive cost guaranteed by high quality materials and optimized design.
3. Customized Designs are available per request

Electronic parameters at room temperature (25°C aro.)

P/N.	Frequency Range	Relative Bandwidth	Insertion Loss	Isolation	VSWR	Operating Temp.	Forward Power	Reverse Power	Direction	Connector
	(GHz)		(dB.Max)	(dB.Min)		(°C)	(W)	(W)		
YXC1801F8	8-12	100%	0.5	20	1.25	-40 ~ +70	10	-	-	SMA
		(4000MHz)								

Mechanical Dimensions (unit: mm)

Pls provide below information when inquiring

The specific working frequency range

- 1- Required specification on IL, Isolation and VSWR
- 2- Power handling
- 3- Connector type
- 4- Other specific requirement details

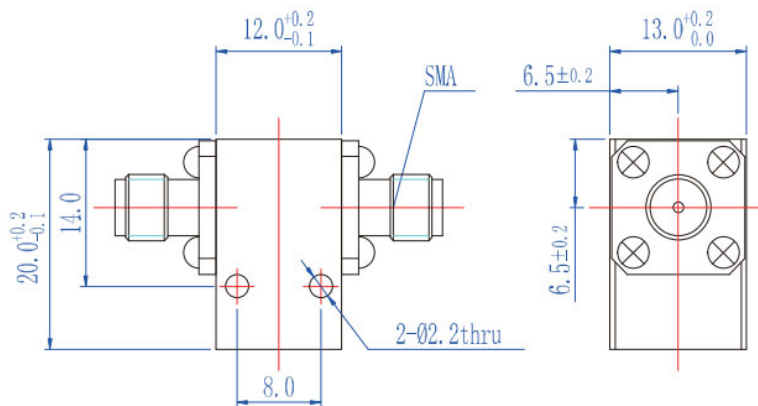

Quanzhou Seven Sunlight Electronic Co., Ltd.

 Web: www.sevensunlight.com Email: sales@sevensunlight.com